

APOLLO *Gate Operators, Inc.*

A member of the NICE group

METRO^{ETL}
METRODUAL^{ETL}
12 VOLT DC Swing Gate Operator

Manufactured by NICE SpA



INSTALLATION MANUAL

CONTENTS

IMPORTANT SAFETY INSTRUCTIONS	3
Applications	4
Pre-Installation Checklist	5
Operator Components	6
Operator Installation.....	7
Gate and Control Box Installation	8
Limit Adjustments	9
Electrical Connections	10
Battery Connections	11
Encoder Board Connections	12
Dimensions and Options	13
Programming Current Sensing	14
Control Board	15-19
Siren Connection	20
Radio Receiver Options	21
Specifications	22
Warranty	23

IMPORTANT SAFETY INSTRUCTIONS

WARNING - To reduce the risk of injury or death:

- **READ AND FOLLOW ALL INSTRUCTIONS.**
- **Installation should be performed by a professional installer.**
- **Should electricity be required, use a certified electrician only.**
- **Any device that requires 120 Volts AC should be U.L. approved.**
- **Install control devices such as keypads far enough away (5 feet or further) from any moving parts of the operator and gate to prevent possible injury.**
- **A secondary entrapment device such as loop detectors, edge switches, and beam detectors are highly recommended and required to meet the UL325 standard.**
- **Review with the owner all safety concerns including:**
 - ⇒ **Do not operate the gate unless area around gate is in full view.**
 - ⇒ **Never let children operate or play with operator controls. Keep the remote control away from children.**
 - ⇒ **Always keep people and objects away from the gate. NO ONE SHOULD CROSS THE PATH OF THE MOVING GATE/ARM.**
 - ⇒ **Test the operator monthly (see page 14 Programming the current sensitivity).**
 - ⇒ **The gate MUST reverse on contact with a rigid object or stop when an object activates the non-contact sensors. After adjusting the force or limit of travel, retest the operator. Failure to adjust and retest the gate operator properly can increase the risk of injury or death.**
 - ⇒ **Arrange with local fire and law enforcement for emergency access.**
 - ⇒ **Always disconnect the battery or power source when making adjustments or repairs to any part of the operator.**
 - ⇒ **The entrance is for vehicles only. Pedestrians must use separate entrance.**
 - ⇒ **Auto Close feature not recommended without a safety device such as a loop detector or photo eye.**

SAVE THESE INSTRUCTIONS

APPLICATIONS

The **Metro Swing Gate Operator** is designed to handle a swing gate up to 10 feet in total length and 400 pounds. **Apollo Operators** are available only through qualified dealers with an outstanding reputation in the fence and gate industry. These dealers will be able to recommend the proper equipment for particular applications. **Apollo Operators** are 12 Volt DC (*Direct Current*) powered. If a electrical battery charger is used a 12 Volt sealed battery (33 ampere hour minimum) is recommended . If solar charging is used a 12 volt 105 ampere hour battery is recommended. There are several advantages with 12 Volt DC systems:

- **Low voltage virtually eliminates risk of electrical shock.**
- **Battery powered operators can provide up to 500 operations in the event of power outages.**
- **The battery may be recharged with a trickle charger or by solar energy (eliminating the need for costly trenching to remote entrances).**

If a trickle charger is used and a standard electrical outlet is not readily available, a licensed electrician will be required for proper electrical hook up.

The following table should be used as a guide for capacity of operation of operators only, additional options may reduce the the daily usage. *Please note that the charge capability of solar panels will vary with different geographical locations. All solar panels and battery chargers are designed for use with a 12 volt battery.*

Daily Cycles →	1-10	1-20	1-40	1-60	1-80	80+
5 watt solar panel	*					
10 watt solar panel		*				
20 watt solar panel (<i>requires SG-4 regulator</i>)			*			
30 watt solar panel (<i>requires SG-4 regulator</i>)				*		
40 watt solar panel (<i>requires SG-4 regulator</i>)					*	
1.5 amp battery charger					*	
10 amp battery charger						*

Note: Double the amount of solar panels for Dual Operators.

PRE-INSTALLATION CHECKLIST

The following checklist should be used before beginning installation:

- ▮ **Verify that the proper operator has been selected for this application.**

- ▮ **Determine the general location of the operator, access controls, and solar panel (if used).**
 1. *Is there a suitable location for the operator?*
 2. *Can the solar panel (if used) be mounted in an unobstructed area facing south?*
 3. *Will additional solar panel cable be required? If additional cable is required, do not cut out the blocking diode when adding the cable.*
 4. *Is electricity available (if required)?*

- ▮ **Consider safety and access options. Recommend if needed.**
 1. *Will there be children or animals in the area?*
 2. *Are safety loops, edge switches, or photo eye detectors required? The auto close feature is not recommended unless one or more of these devices are used.*
 3. *How can the gate be opened in emergencies?*
 4. *How will visitors enter and exit?*
 5. *Will vehicles (and trailers) have sufficient room off roadway to operate access control devices such as keypads?*

OPERATOR COMPONENTS

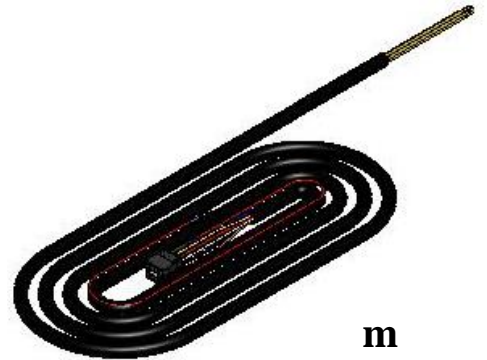
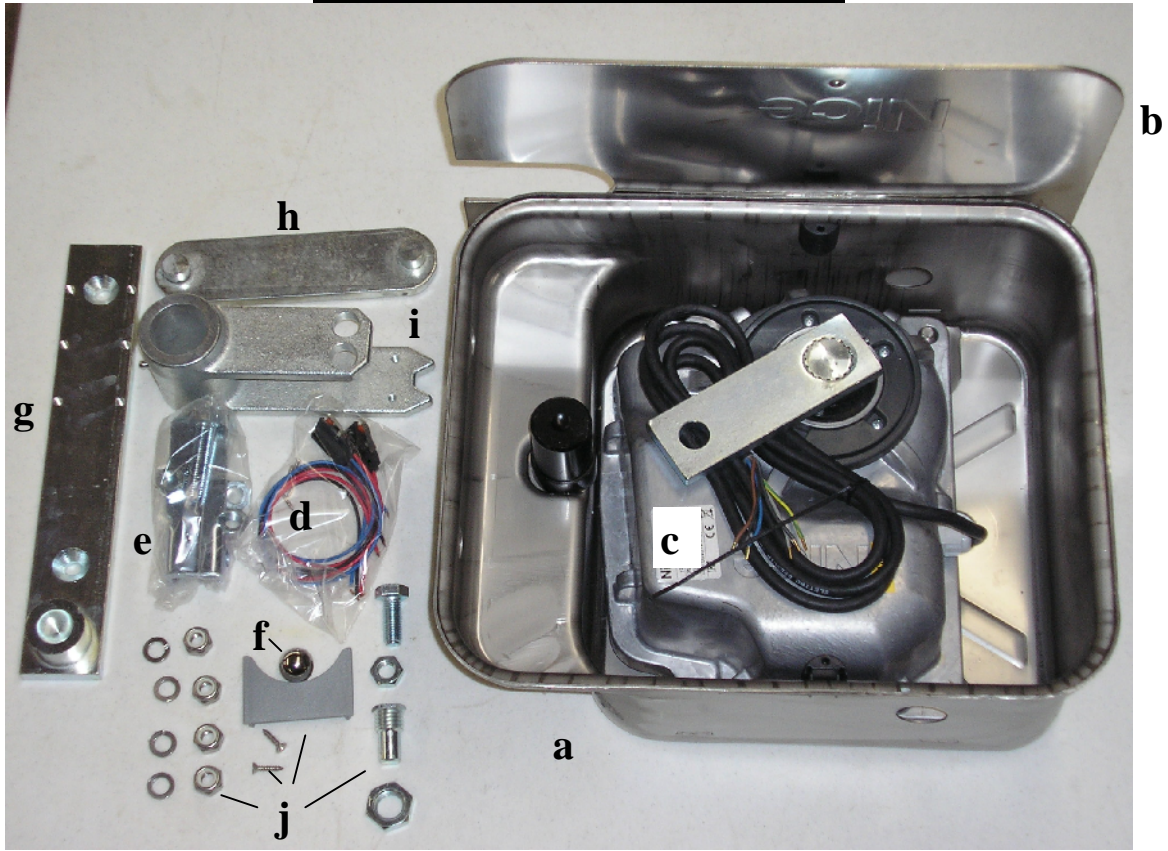

- k Control box
- l Caution signs (2)
- m Cable
- n Battery charger (optional)
- o Solar panel (optional)

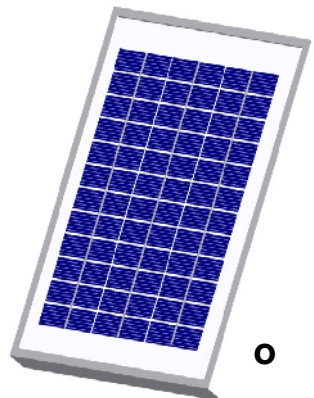

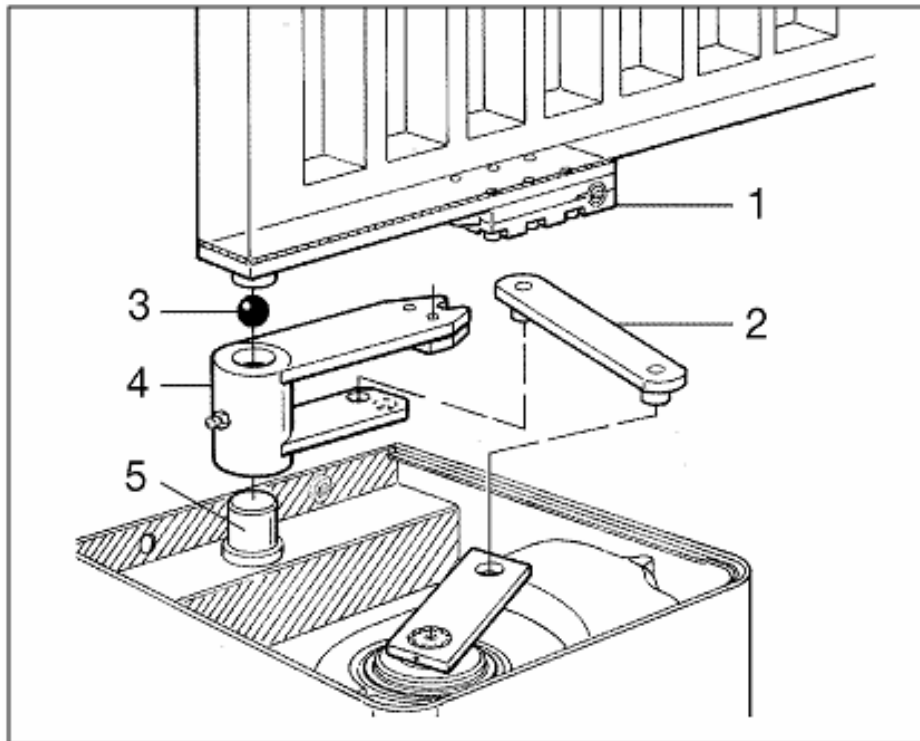

- 1 Release lever
- 2 Connecting lever
- 3 Ball
- 4 Control bracket
- 5 Pin

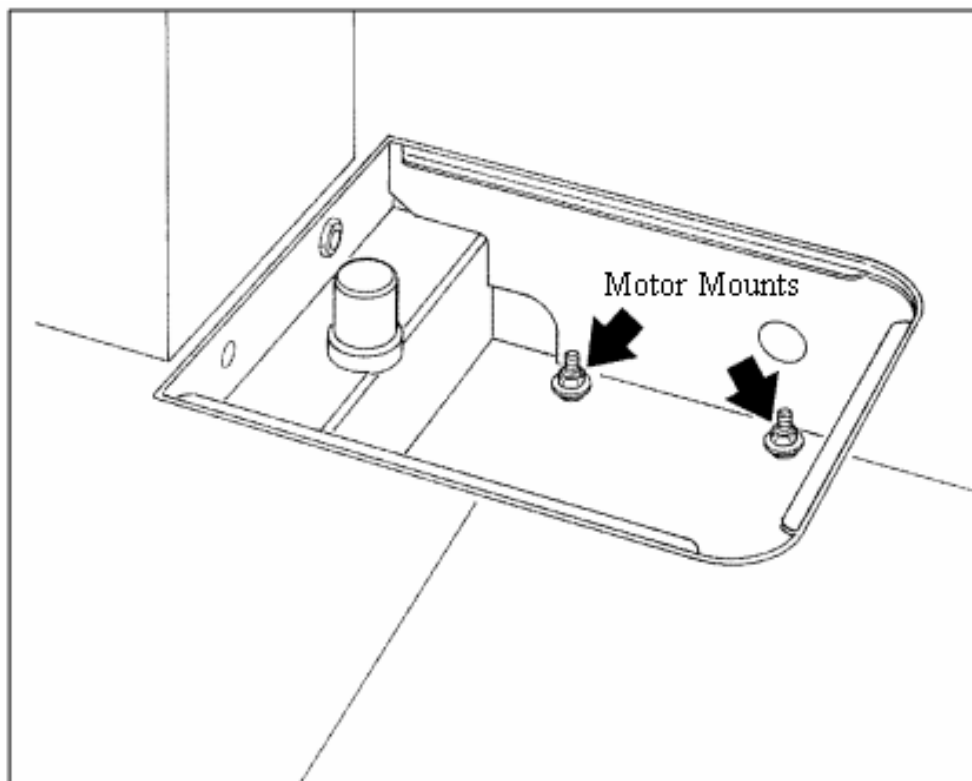

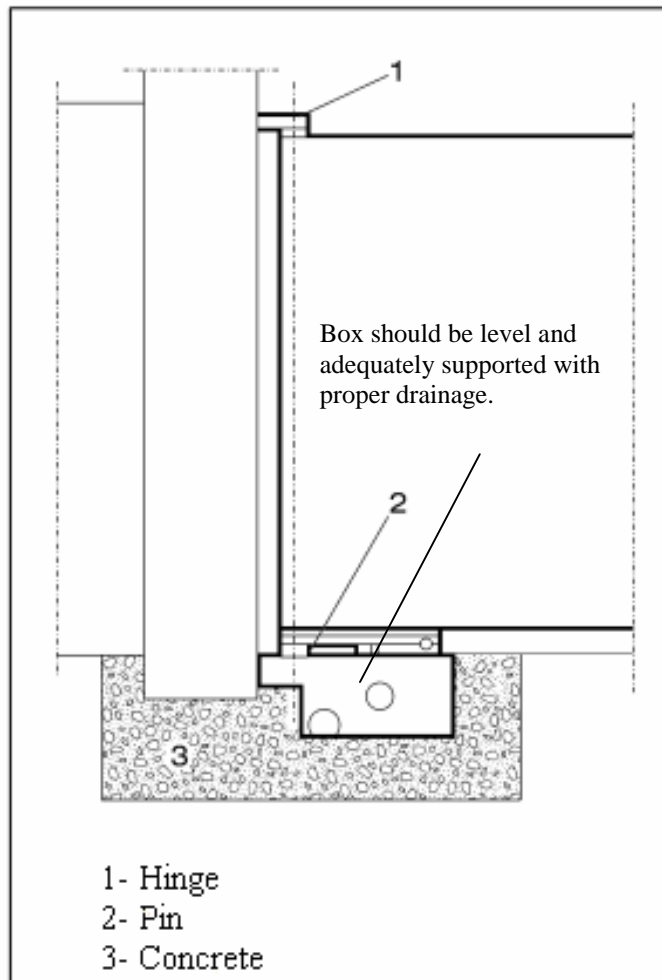

Control Box Installation

Mount the control box so that cable(8') will reach the motor. **Do not mount the control box where the person using the push button on side of the box can come in contact with the gate.** Use mounting hardware capable of supporting the weight of the control box with the battery installed.

Set battery inside of control box with terminals toward the front (*Do not use any battery with side terminals*).

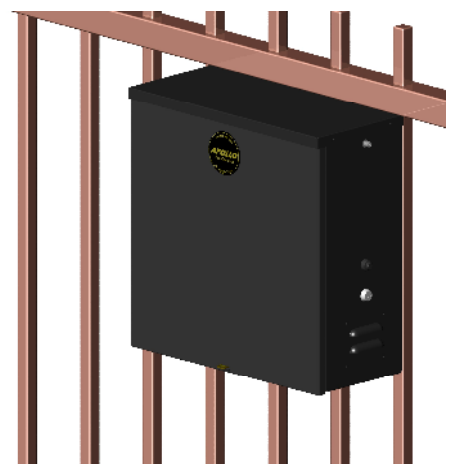

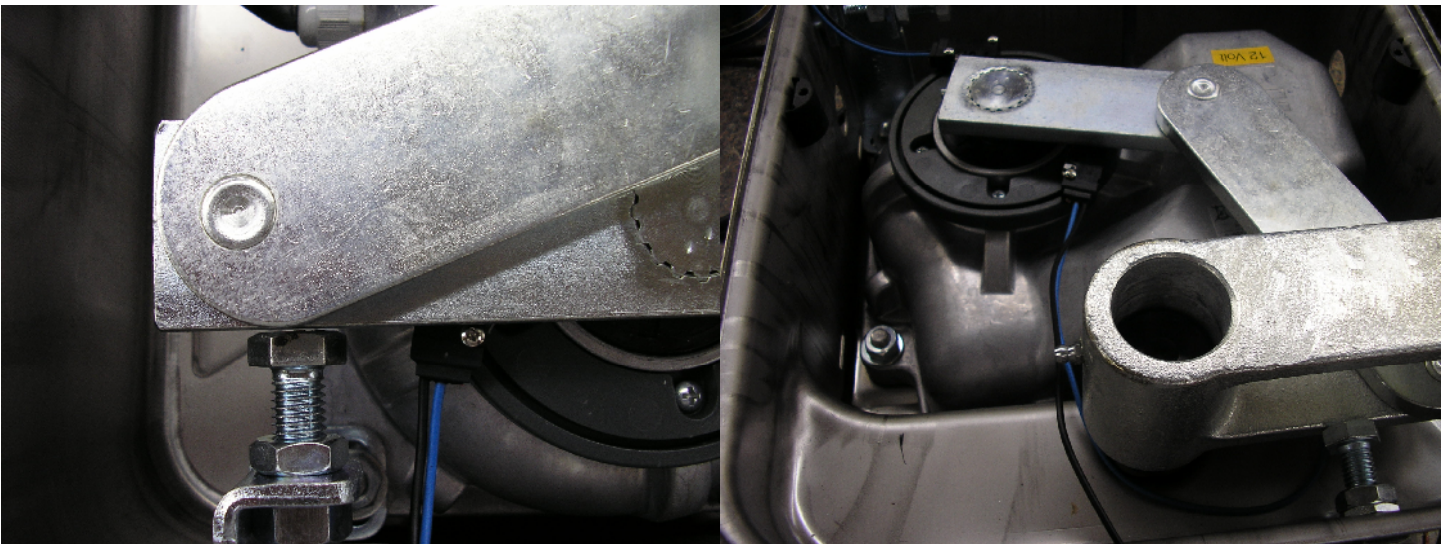
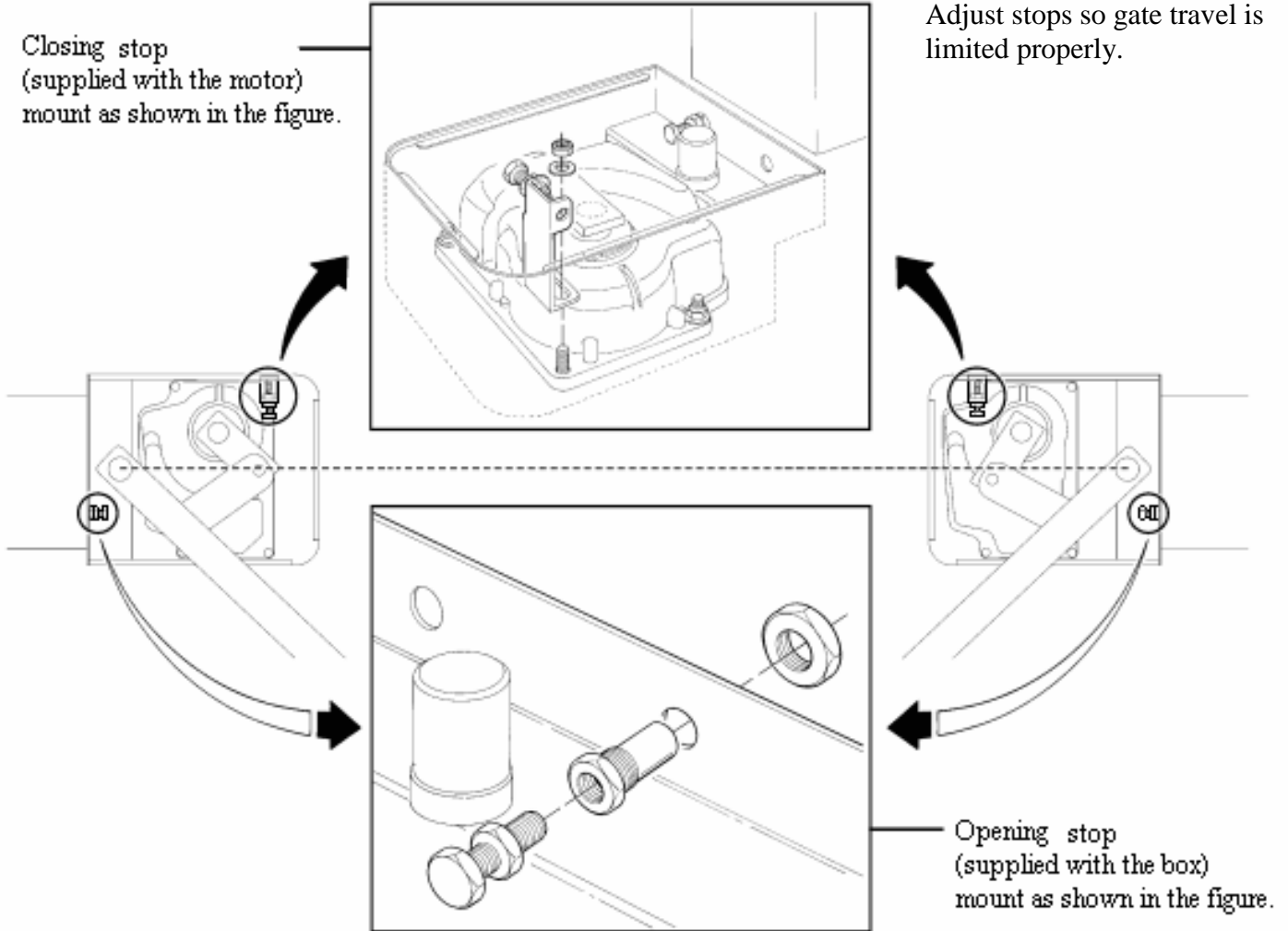

Move arm to close stop and install close limit switch with supplied screws so that switch is activated..

Move arm to open stop and install open limit switch with supplied screws so that switch is activated.

Note: Limit switches may be adjusted later for precise open and close positions.

Metro_{etl} Operator Wiring

Diagram for left mounted operator

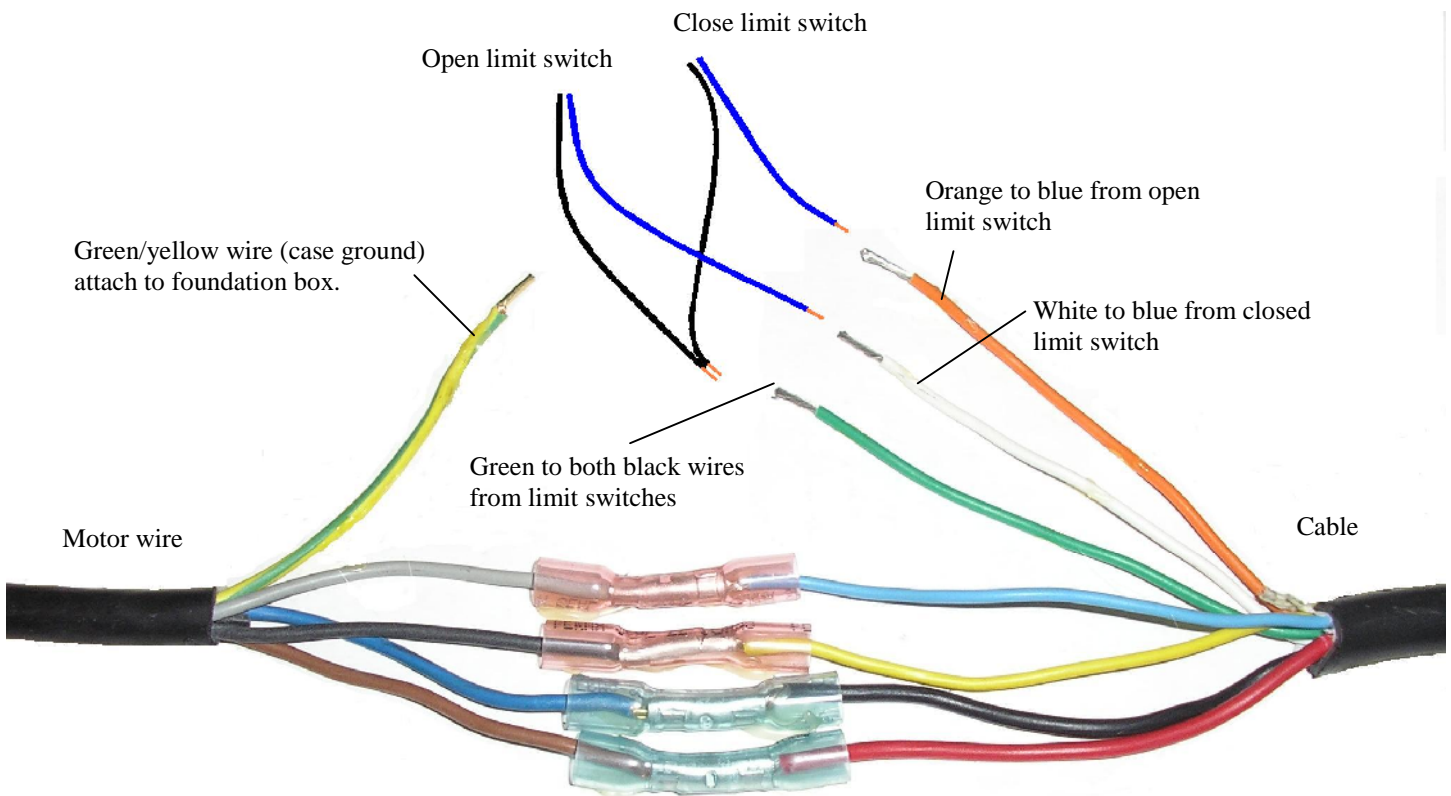

From motor - - Cable / Harness

- Brown - Red
- Blue - Black
- Black - Yellow
- Grey - Blue

NOTE: For right mounted operators, blue motor wire goes to red cable wire, brown motor wire to black cable wire.

To verify motor wiring– place gate half way open, plug main harness into emergency bypass for 2 seconds. Gate should open if it closes, reverse red and black wires.

To verify limits, enable LEDs on board– verify open limit when gate opens and closed limit when closed - If reversed– swap limit switch positions.

BATTERY CONNECTIONS

If a electrical battery charger will be used, a 12 volt sealed lead acid battery rated for 33 ampere hour or more is recommended for the **METROETL**. A 1.5 amp automatic battery charger is sufficient for most applications

The battery may also be recharged with a solar panel. If solar charging is a requirement refer to page 4 or contact our customer service department at 800 226-0178 to help determine the solar panel size needed. A 12 volt 105 ampere hour battery is recommended with solar charging.

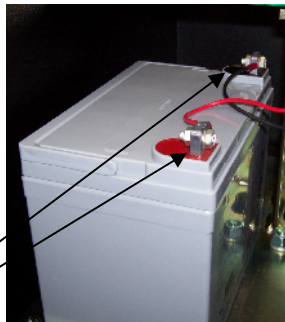

Connect the two ring terminals on the connector end of the cable to the battery. The battery charger or solar panel should be installed at this time.

(RED is positive(+)) and Black is negative

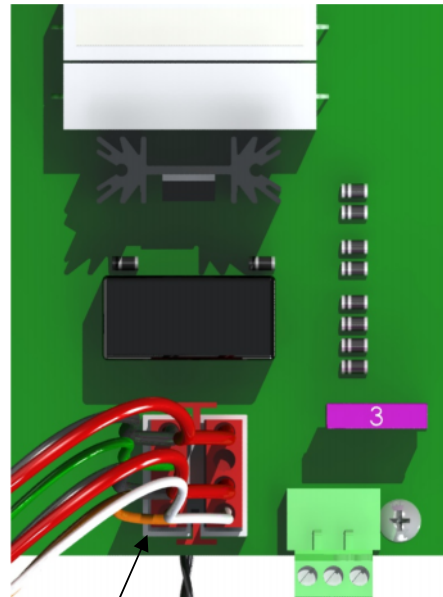

Plug the Metro operator connector into the Master connector on the circuit board.

The operator is now active. Limits must be set and tested. The current sense must now be programmed as shown on page 14.

If the operator does not work, check the battery connections for proper polarity. If the connections are reversed, the **“REVERSE BATTERY POLARITY”** LED will be illuminated at the bottom center of the circuit board.



METRO Wiring Diagram

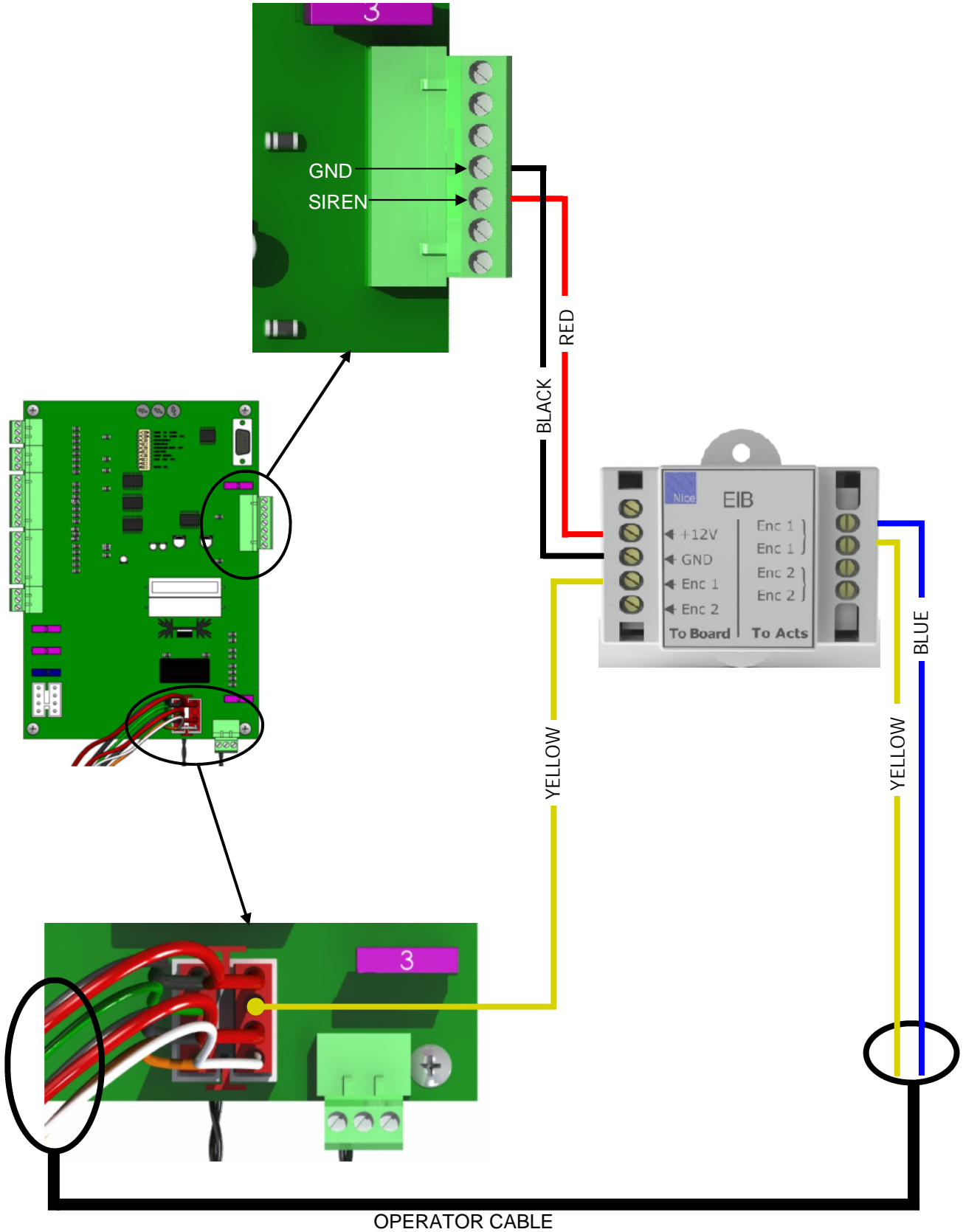

METROETL

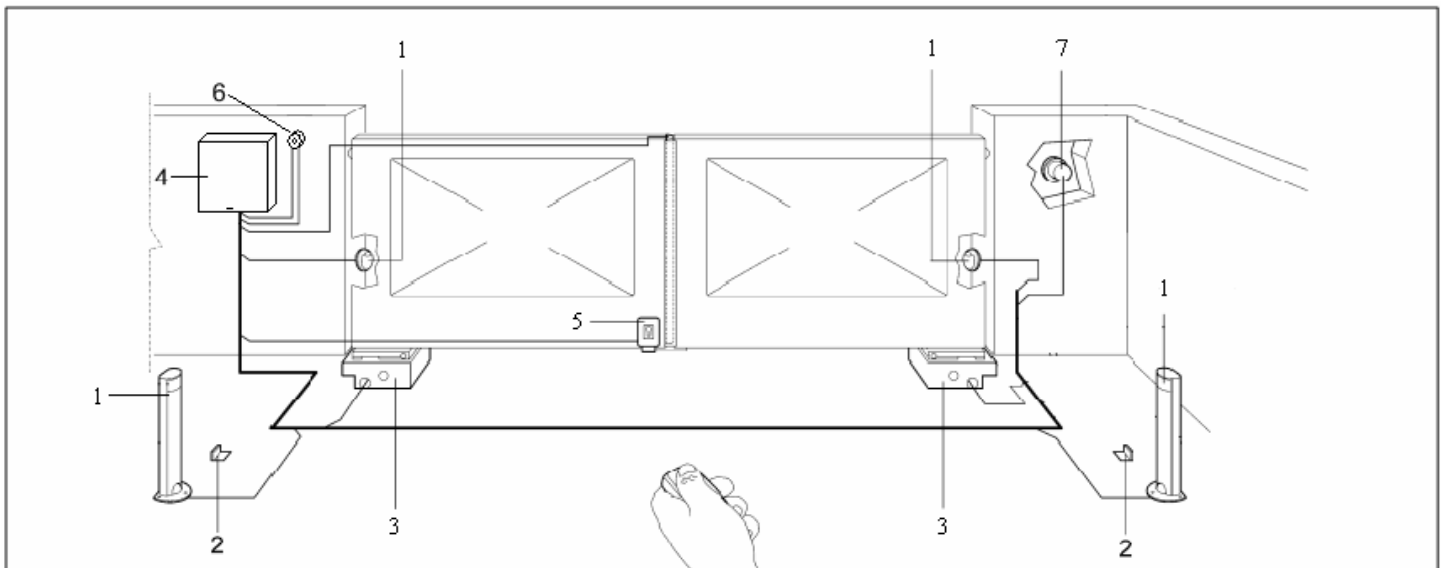
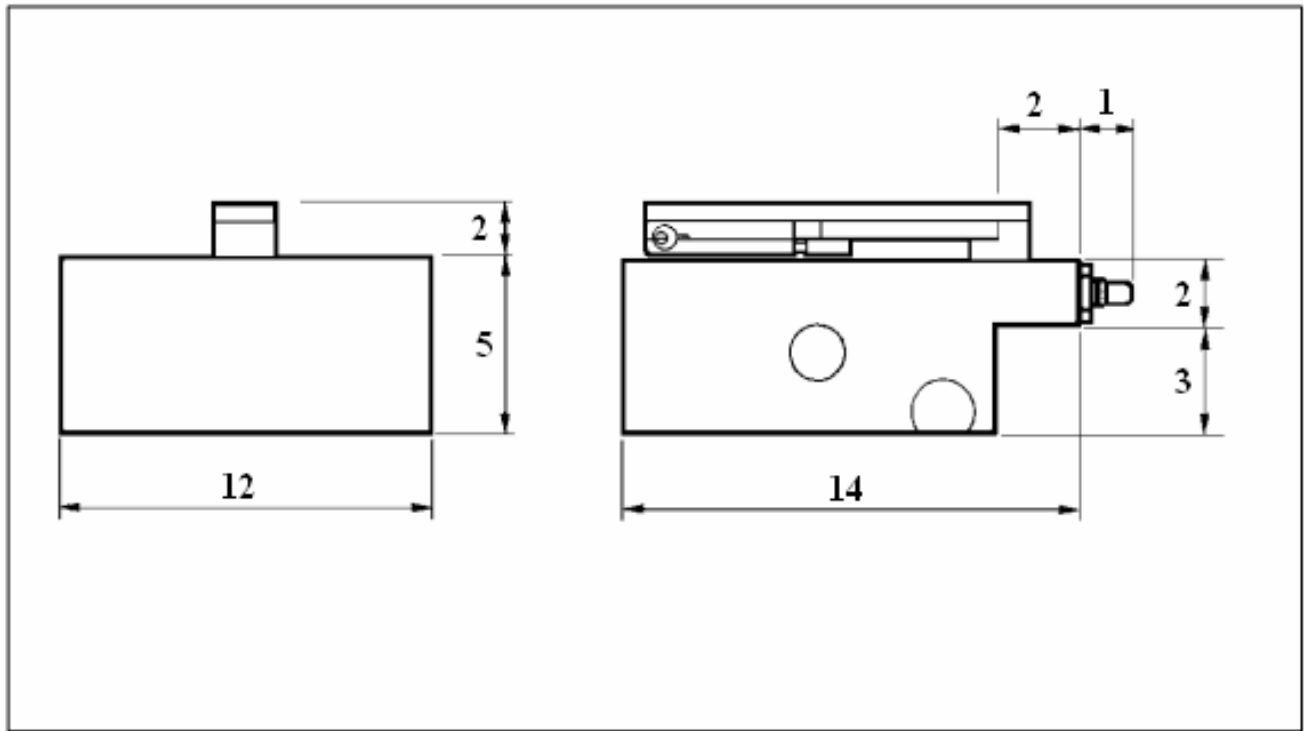

- | | | | |
|---------------------------|----------|-----------------|----------|
| 1 Photo Beam | Optional | 5 Solenoid lock | Optional |
| 2 External Stops | Optional | 6 Siren | |
| 3 Box with METRO actuator | | 7 Keypad | Optional |
| 4 Control box | | | |

PROGRAMMING CURRENT SENSING

The **835/836** control boards incorporate a safety feature that will put the operator into a hard shutdown mode if the control board detects a current sense two consecutive times during a cycle. This hard shutdown condition may be reset by shorting the **FIREBOX** or **UL** inputs on the left side of the control board to ground. This condition may also be reset by pressing the **HARD SHUTDOWN RESET** button located toward the upper right hand corner of the control board. If a firebox is used in the installation, The firebox door (optional) can be opened and closed to reset the control board.

The following instructions must be followed at installation for proper safety assurance.

All limits must be set before beginning this procedure.

See page 9 & 10

1. Press and hold the **LED ENABLE** button for five seconds and release. The **STOP LED** will blink indicating that the board is in learn mode.
3. Cycle gate/arm for 3-4 full cycles. The **STOP LED** will stop blinking indicating that the operator is now ready for normal operation
4. Test the auto reverse sensitivity by obstructing the gate to ensure maximum safety protection. The current sensitivity adjustment pot may be adjusted to decrease or increase sensitivity.

Perform this test procedure on a monthly basis to assure proper and safe operation.

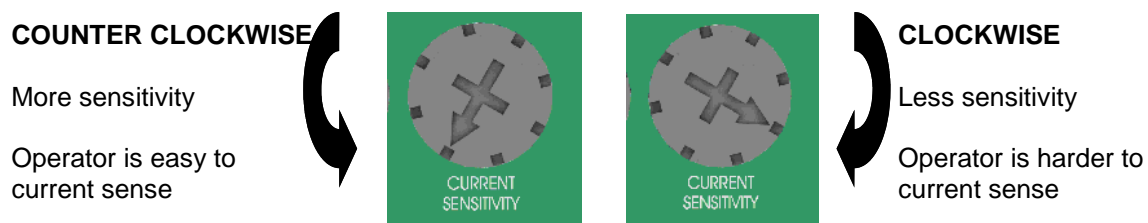

8. Refer to the page 17&18 to set other options such as program switch options and close timer adjustments.

Installation is now complete.

Note: Once the board has learned the operator, the current sense may be readjusted at any time without re-learning the board..

835/836 Control Board Parts Identification

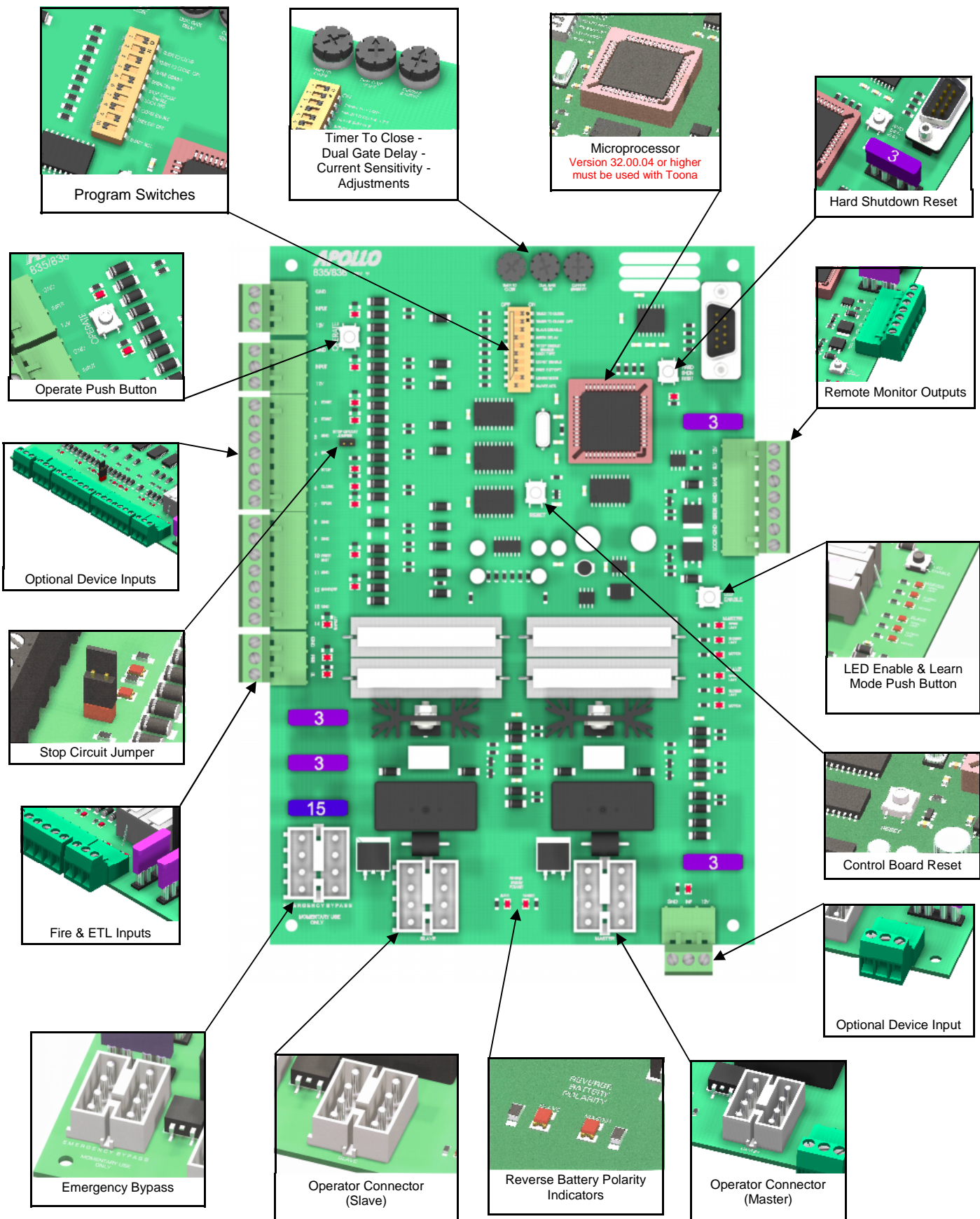

Master/Slave Connector

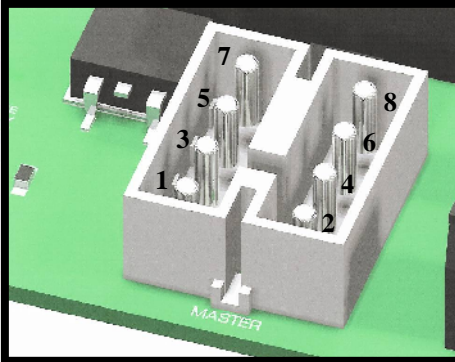

Board	Harness	Function
Pin 1	Orange	Open Limit
Pin 2	White	Close Limit
Pin 3	Black	Motor (positive on open, negative on close)
Pin 4	Red	Motor (negative on open, positive on close)
Pin 5	Green	Common for both limit switches
Pin 6	Yellow	Encoder Input from EIB module
Pin 7	Black	Battery Negative
Pin 8	Red	Battery Positive

EMERGENCY BYPASS

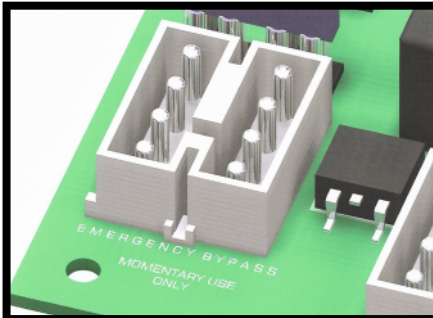

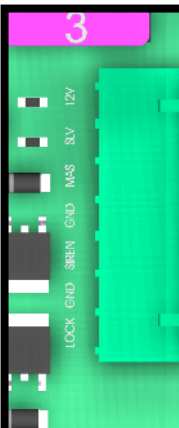

Applies battery voltage directly to motor to open gate (will not close gate) if control board fails. User must unplug before gate opens to maximum travel or the 15 amp fuse will open. Fuse should be checked before returning gate to service.

Remote Outputs



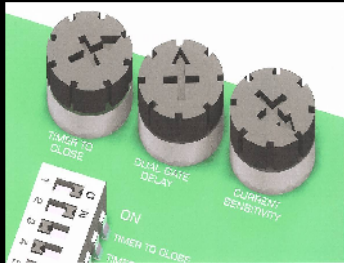

12V	Supplied battery voltage
SLV	Slave Operator Indicator (indicates slave side of gate is closed) +12V when on closed limit. Ground when off of closed limit.
MAS	Master Operator Indicator (indicates master side of gate is closed) +12V when on closed limit. Ground when off of closed limit.
GND	Battery supplied ground (connects to GND on EIB module)
SIREN	Connect to siren + (also connects to +12V on EIB module) applies +12V when gate(s) are running, or in hard shutdown
GND	Battery supplied ground
LOCK	Connect to lock + (optional) Magnetic or Solenoid type locks (Dip Switch #6 Selectable)

Adjustments

	<p>TIMER TO CLOSE Adjusts time before gate automatically closes Adjustable 5 to 70 seconds.</p>
	<p>DUAL GATE DELAY (Dual board only) Adjusts delay between master and slave operation 0-4 seconds (836 only with magnetic, solenoid, and other locking devices)</p>
	<p>CURRENT SENSITIVITY Increases or decreases the Auto Reverse sensitivity.</p>

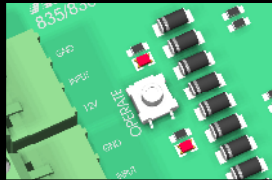
Push Buttons

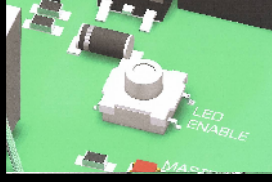
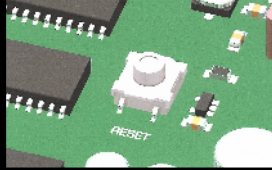
	<p>OPERATE When depressed, activates the gate. Used for initial installation and testing.</p>
	<p>Hard Shutdown Reset Resets the operator when the gate current senses twice before fully opening or closing.</p>
	<p>LED ENABLE When depressed, activates LEDs for 15 minutes to assist in installation and troubleshooting.</p> <p>Hold the push button down for five seconds to put the board in program mode.</p>
	<p>RESET Resets the microprocessor. Returns processor to last known state.</p>

Jumpers

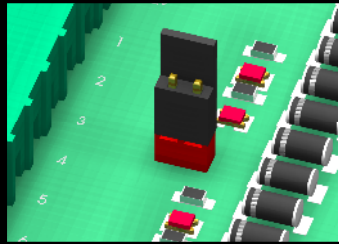
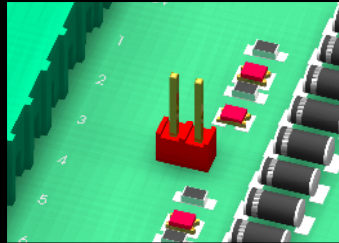
	<p>STOP CIRCUIT JUMPER When the STOP CIRCUIT JUMPER is connected, the gate will operate normally.</p>
	<p>STOP CIRCUIT JUMPER When a 3-button station is connected to the board, the STOP CIRCUIT JUMPER must be removed.</p>

Program Switches

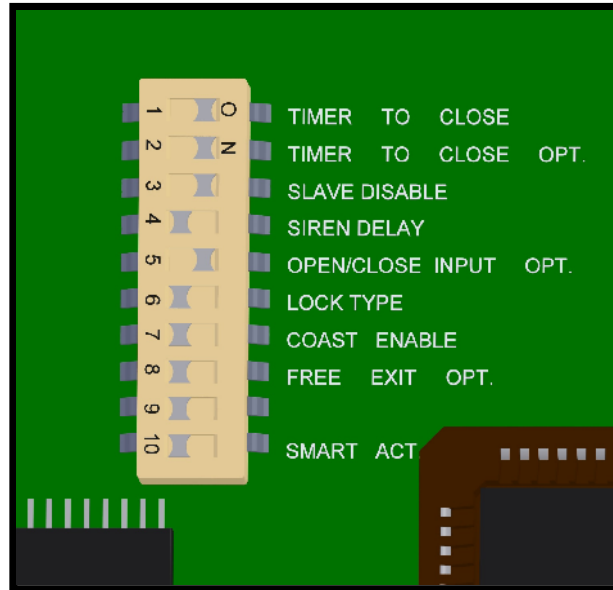





OFF

ON

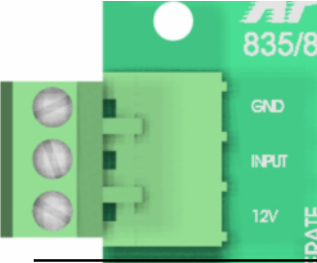
1 TIMER TO CLOSE	Gate does not automatically close.	Gate automatically closes.
2 TIMER TO CLOSE OPT.	Gate automatically closes from any position after opening.	Gate automatically closes only when completely open (open limit engaged).
3 SLAVE DISABLE	Enables slave side (dual gate use).	Disables slave side. (single gate use)
4 SIREN DELAY	Siren (optional) active when gate is moving.	Siren (optional) starts 5 seconds before gate moves.
5 OPEN/CLOSE INPUT OPT.	Must hold down open or close buttons to move gate. Gate stops when button released.	Normal operation Momentary open or close input runs gate to limit.
6 LOCK TYPE	For 12V mechanical (solenoid) locks. (+12V for 4 seconds on open cycle)	For 12V magnetic locks. (+12V when on close limit)
7 COAST ENABLE	Gate will stop immediately when at Open or Close limit	Gate will coast (minimally) when it reaches limits. Not recommended for slide gates using chain magnets.
8 FREE EXIT OPT.	A free exit input will open gate from closed position or after a close cycle only.	A free exit input will open gate from any position after an open or close cycle.
9 DUAL GATE SYNC	Both gates operate at normal Speed (slave slower than Master).	This feature will control the master gate to open or close at the same speed as the slave gate.
10 SMART ACT.	Off for all slide gate operators and 1500/1600/3500/3600 swing Gate operators.	On for 1550/1650/Toona 5&7/Metro/Hyppo Enables soft start & soft stop.

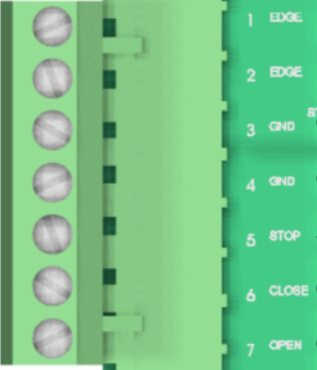
Optional Device Inputs

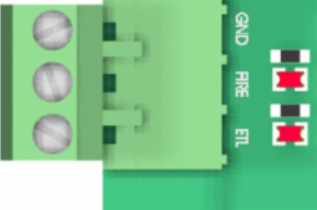
	GND	Supplied Battery Ground
	INPUT	Activate Gate (Push button activation when momentarily shorted to ground)
	12V	Supplied Battery Voltage (Protected with 3 Amp fuse)
	GND	Supplied Battery Ground
	INPUT	Activate Gate (Push button activation when momentarily shorted to ground)
	12V	Supplied Battery Voltage (Protected with 3 Amp fuse)
	1 EDGE	Reverse edge input. When grounded, will stop and reverse gate if closing, resets close timer if gate is open.
	2 EDGE	Reverse edge input. When grounded, will stop and reverse gate if closing, resets close timer if gate is open.
	3 GND	Supplied Battery Ground
	4 GND	Supplied Battery Ground
	5 STOP	Stop input from a 3 button station (must remove STOP CIRCUIT JUMPER) Normally closed
	6 CLOSE	Close input from a 3 button station (see program switch #5 for options)
	7 OPEN	Open input from a 3 button station (see program switch #5 for options)
	8 GND	Supplied Battery Ground
	9 GND	Supplied Battery Ground
	10 FREE EXIT	Opens gate if closed, stops and reverses gate if closing, resets close timer if gate is open.
	11 GND	Supplied Battery Ground
	12 SHADOW	Resets close timer when gate is open (also referred to as under gate loop)
	13 GND	Supplied Battery Ground
	14 SAFETY	Resets close timer if gate is open, stops and reverses if gate is closing. (Does not open a closed gate)
	GND	Supplied Battery Ground
	FIRE	When grounded, opens gate and holds gate open until released. Clears "Hard Shutdown" mode of software.
	UL	When grounded, opens gate and holds gate open until released. Clears "Hard Shutdown" mode of software.

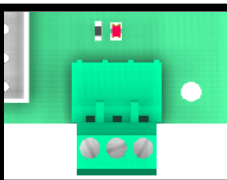
	GND	Supplied Battery Ground
	INPUT	Activate Gate (Push button activation when momentarily shorted to ground)
	12V	Supplied Battery Voltage (Protected with 3 Amp fuse)

911 Siren

The 911 Siren is included with all Apollo ETL Gate Operators.

Mount siren in an area that will produce maximum performance (additional wire may be required).

Connect the red wire to the SIREN connector on the Remote Monitor Output Connector block.

Connect the black wire to the GND connector on the Remote Monitor Output Connector block.

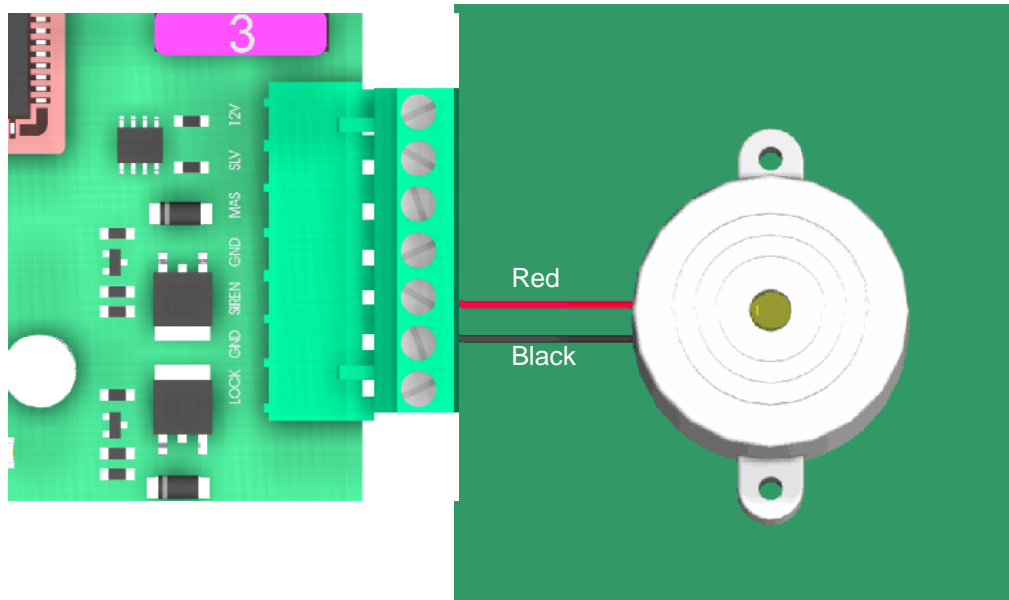

Set Program Switch # 4 as preferred:

ON - Upon activation, Siren will start for 5 seconds before gate(s) begin moving.

OFF - Siren and gate(s) start immediately upon activation.

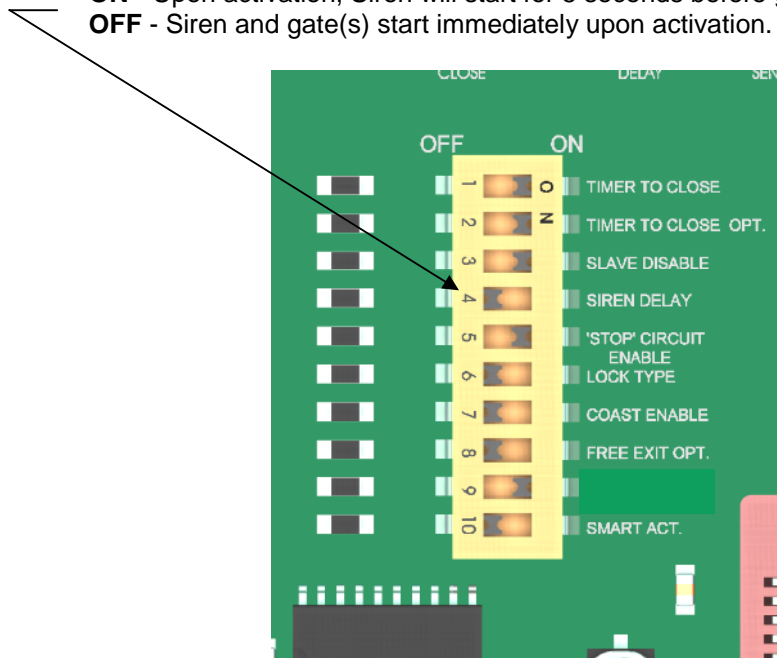

APOLLO *Gate Operators* RECEIVER OPTIONS

Do not confuse the receiver code switches with the red program switches on the gate control board.

Never set all code switches to the same position. Transmitters must match code switches for proper operation.

If power is taken directly from battery or connected as shown below, receiver should be configured for 12VDC

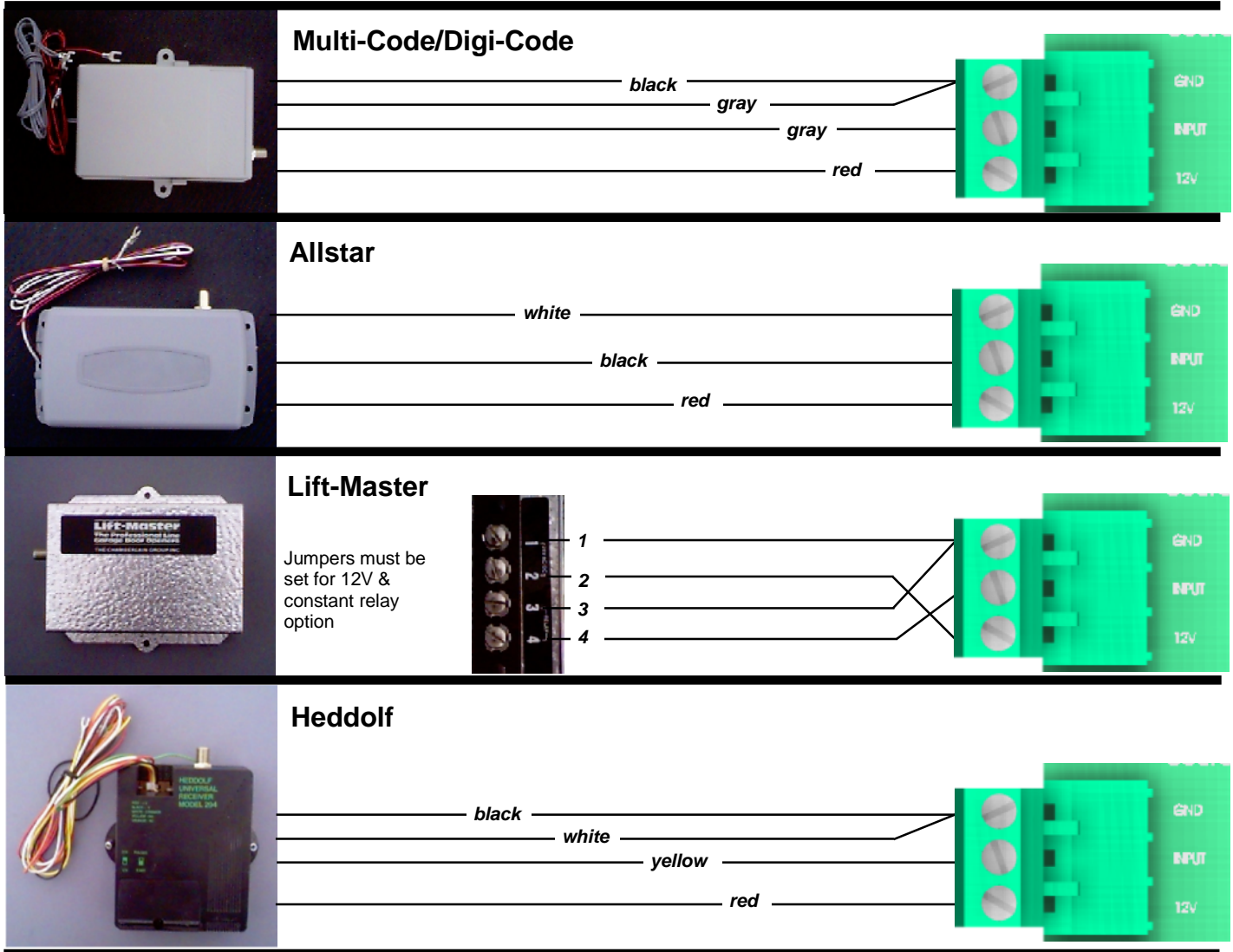

SPECIFICATIONS

Supply Voltage	12VDC
Recommended Battery (electrically charged)	12 V, 33aH (or larger) Sealed Lead Acid
Recommended Battery (solar charged)	12 V, 105 aH
Battery Charger	1.5 or 6 amp Automatic
Recommended Solar Panel	5 watt minimum
Duty Cycle	40 percent
Operating Temperature	-20°C - +50°C
Current Draw Standby (with no accessories).....	10mA
Current Draw Operating	2A

APOLLO Gate Operators, Inc.

LIMITED TWO-YEAR WARRANTY

Apollo Gate Operators are warranted against defects for a period of 24 months from the date of purchase, providing recommended installation procedures are followed. This warranty is in lieu of all other warranties expressed or implied (some states do not allow limitations on how long an implied warranty lasts, so this limitation may not apply to you) and shall be considered void if damage was due to improper installation or use, connection to improper power source, or if damage was caused by fire, flood, or lightning. The manufacturer will not be responsible for any labor charges incurred in the removal or replacement of defective parts.

In case of failure due to defective material or workmanship during the warranty period, the defective part will be repaired or replaced at the manufacturer's option at no charge if returned freight prepaid. New or factory rebuilt replacements may be used. Replacement parts are warranted for the remaining portion of the original warranty period. The manufacturer will pay standard ground freight back to the customer on the return of repaired or replaced items in warranty.

Lighting or electrical power surges may cause damage beyond repair and are not covered in this warranty.